

TSL-1206UG000MTH



FEATURES

- Wide Viewing Angle 120°
- Reflow Solderable
- High Luminous Intensity and Low Power Dissipation
- Good Reliability and Long Life
- Complied With RoHS Directive

APPLICATIONS

- Optical indicator
- Indoor display
- Backlighting in dashboard and switch
- Flat Backlighting for LCD, symbol and display
- General use

TECHNICAL DATA SHEET

This product is generally used as indicator and luminary for electronic equipment such as household appliance, communication equipment and dashboard.

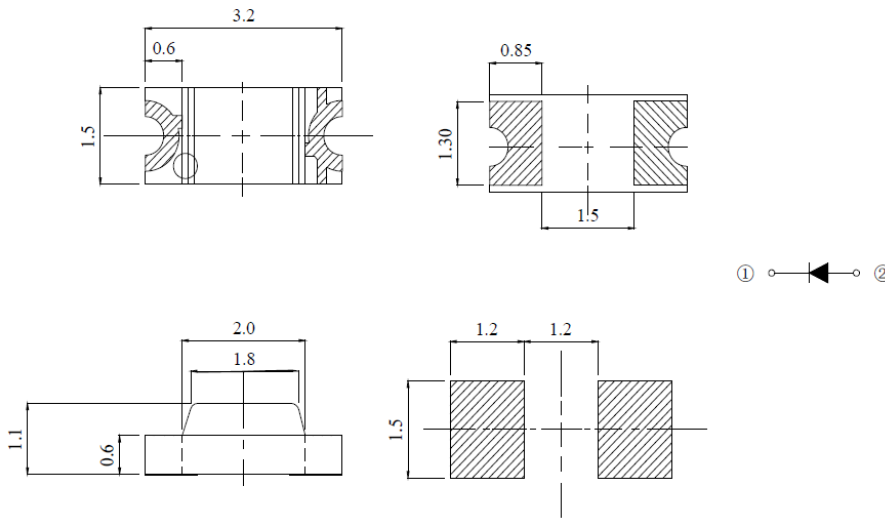

Notes:

1. All dimension units are millimeters.
2. All dimension tolerance is $\pm 0.2\text{mm}$ unless otherwise noted.

Selection Guide

Dice	Lens Type	Luminous intensity (mcd) @ 20mA			Viewing Angle
		Min	Typ	Max	2 θ 1/2
Green (InGaN)	Water Clear	150	400	800	120

Note:

1. 1/2 is the angle from optical centerline where the luminous intensity is 1/2 the optical centerline value.
2. The above luminous intensity measurement allowance tolerance $\pm 10\%$

Electrical / Optical Characteristics at Ta=25°C

Parameter	Symbol	Min.	Typ.	Max	Units	Test conditions
Forward Voltage	VF	2.8	3.0	3.6	V	IF=20mA
Reverse Current	IR	--	--	10	uA	VR=5V
Dominant Wavelength	λ_d	515	--	525	nm	IF=20mA

Absolute Maximum Ratings at Ta=25°C

Parameter	Symbol	Rating	Units
Power Dissipation	Pd	160	mW
DC Forward Current	IF	25	mA
Peak Forward Current 【1】	IFP	100	mA
Reverse Voltage	VR	5	V
Electrostatic Discharge (HBM)	ESD	± 2000	V
Operating Temperature	Topr	-30~+85	°C
Storage Temperature	Tstg	-40~+100	°C

Note:

1. 1/10 Dut cycle, 0.1ms pulse width.
2. The above forward voltage measure ment allowance tolerance $\pm 0.1\text{V}$.

TSL-1206UG000MTH

Typical Optical Characteristics Curves

Ambient Temperature VS. Forward Current

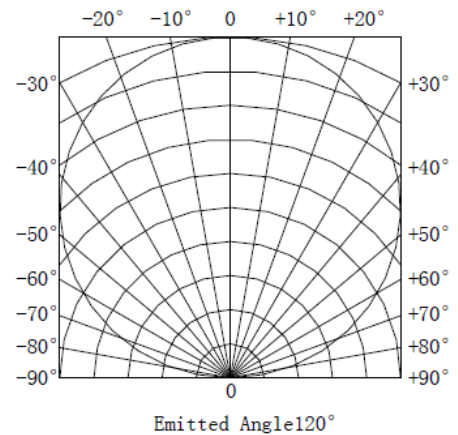
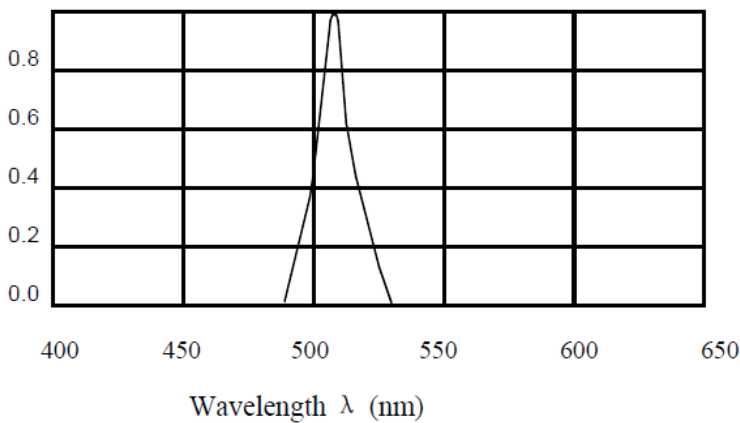
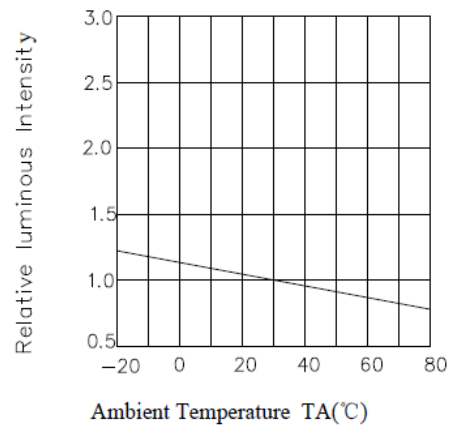
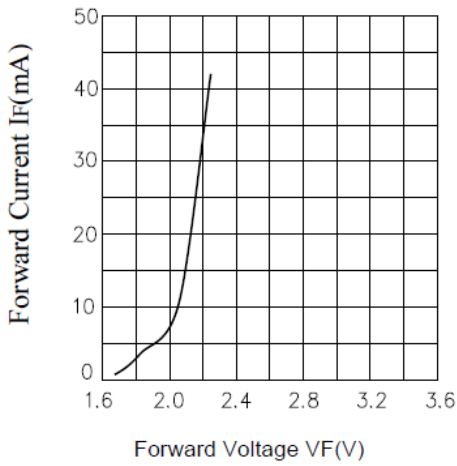
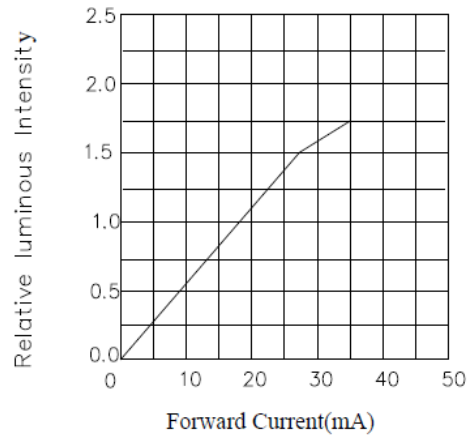
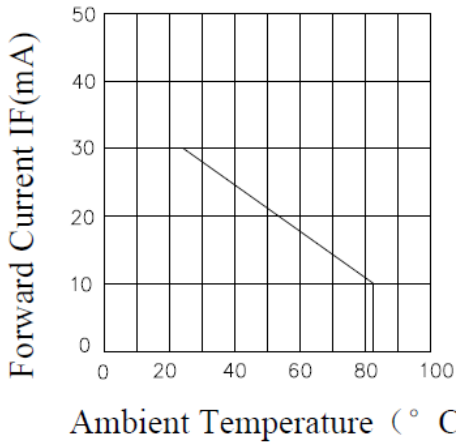

TSL-1206UG000MTH

Carrier Tape

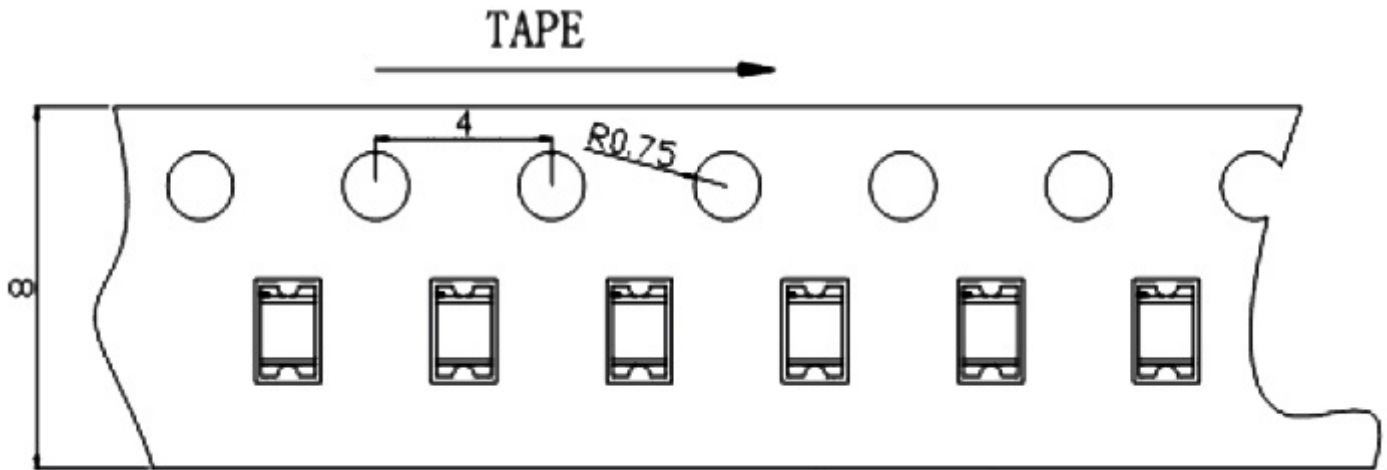

All dimensions in mm, tolerances unless mentioned is ± 0.1 mm.

Moisture Resistant Packaging

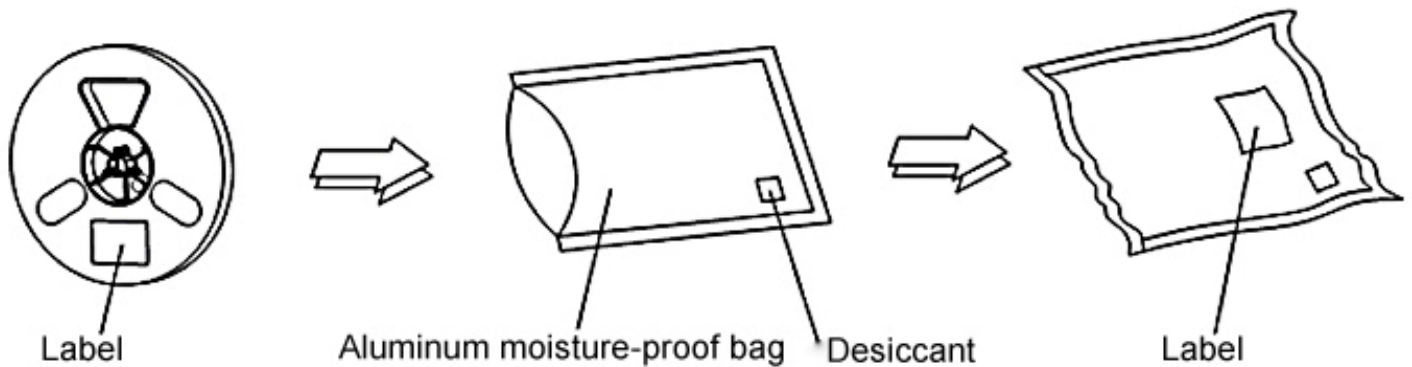

Note: Specification are subject to change without notice. For more detail and update, please visit our website.