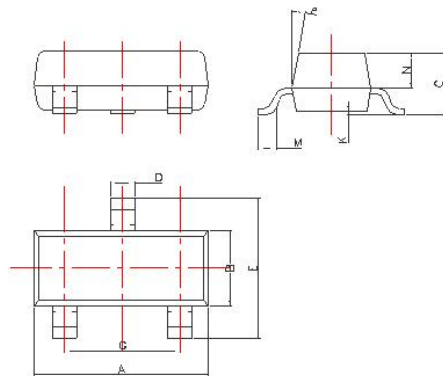
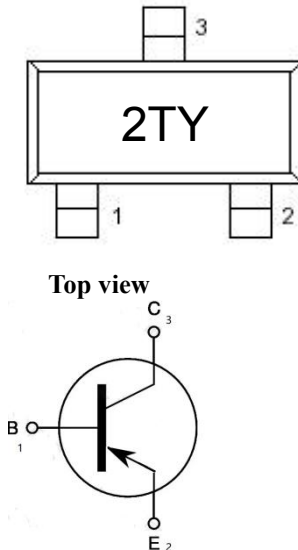

CDTA8550-ME

TRANSISTOR

Marking: 2TY

SOT-23 Dimension

SOT-23
Suggested Layout

DIM	Millimeters
A	2.85~3.04
B	1.30±0.10
C	1.00±0.10
D	0.45±0.05
E	2.25~2.55
G	1.90±0.1
K	0.00~0.10
M	0.20 min
N	0.60±0.10
P	7±2°

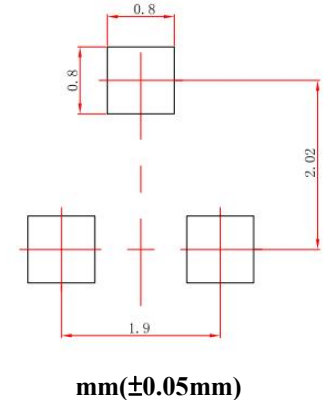

mm(±0.05mm)

MAXIMUM RATINGS (Ta=25°C)

Characteristic	Symbol	Rating	Unit
Collector-Emitter Voltage	V_{CEO}	-25	Vdc
Collector-Base Voltage	V_{CBO}	-40	Vdc
Emitter-Base Voltage	V_{EBO}	-5.0	Vdc
Collector Current - Continuous	I_C	-500	mAdc

THERMAL CHARACTERISTICS

Characteristic	Symbol	Max	Unit
Collector Power Dissipation	P_c	300	mW
Junction and Storage Temperature	T_j , T_{stg}	150 , -55 ~150	°C

ELECTRICAL CHARACTERISTICS (Ta=25°C unless otherwise noted)

Characteristic	Symbol	Test Condition	Min	Type	Max	Unit
Collector Cutoff Current	I_{CBO}	$V_{CB}=-30V, I_E=0$	--	--	-0.1	μA
Collector- Emitter Cutoff Current	I_{CEO}	$V_{CB}=-20V, I_E=0$	--	--	-0.1	μA
Emitter Cutoff Current	I_{EBO}	$V_{EB}=5V, I_C=0$	--	--	-0.1	μA
Collector-Emitter Breakdown Voltage	$V_{(BR)CEO}$	$I_C=-1mA$	-25	--	--	V
Collector- Base Breakdown Voltage	$V_{(BR)CBO}$	$I_C=-100\mu A$	-40	--	--	V
Emitter-Base Breakdown Voltage	$V_{(BR)EBO}$	$I_E=-100\mu A$	-5	--	--	V
DC Current Gain	$h_{FE}(1)$	$V_{CE}=-1V, I_C=-100mA$	200	--	350	--
	$h_{FE}(2)$	$V_{CE}=-1V, I_C=-0.5A$	40	--	--	
Collector-Emitter Saturation Voltage	$V_{CE(sat)}$	$I_C=-500mA, I_B=-50mA$	--	--	-0.6	V
Base Emitter Voltage	V_{BE}	$V_{CE}=-1V, I_C=-10mA$	--	-0.8	-1.2	V
Transition Frequency	f_T	$V_{CE}=-5V, I_C=-10mA$	--	120	--	MHz
Collector Output Capacitance	V_{ob}	$V_{CB}=-10V, I_E=0,$ $f=1MHz$	--	13	30	pF

- FR-5=1.0x0.75x0.062in.
- Alumina=0.4x0.3x0.024in, 99.5% alumina.
- Pulse Width ≤300μS; Duty Cycle ≤2.0%.

CDTA8550-ME

TRANSISTOR

Typical Characteristics

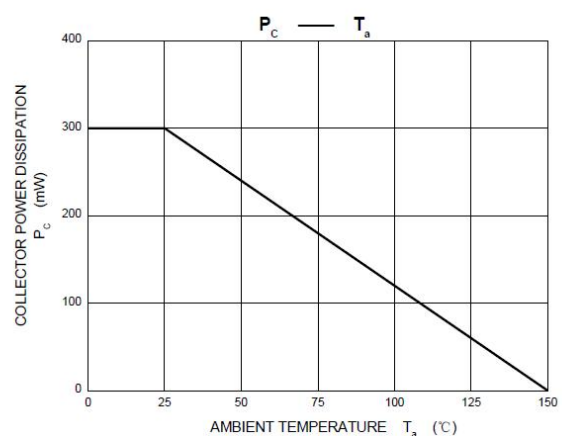
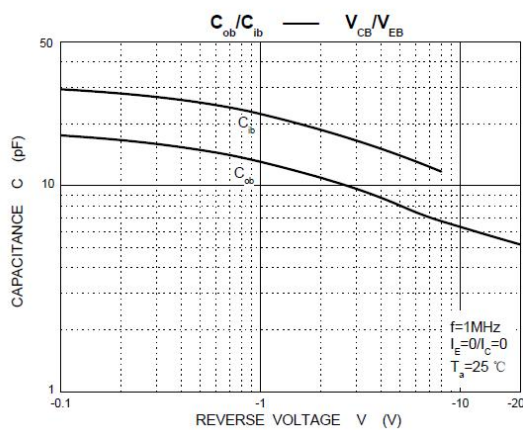
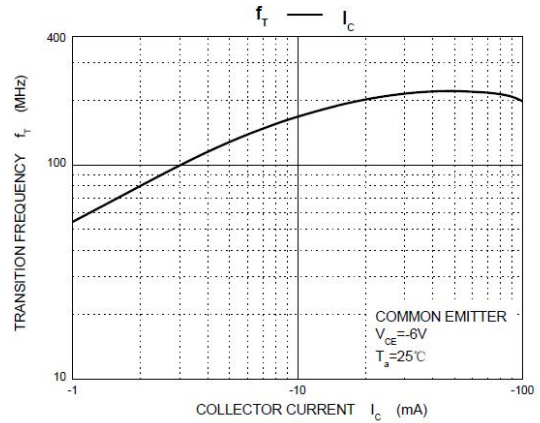
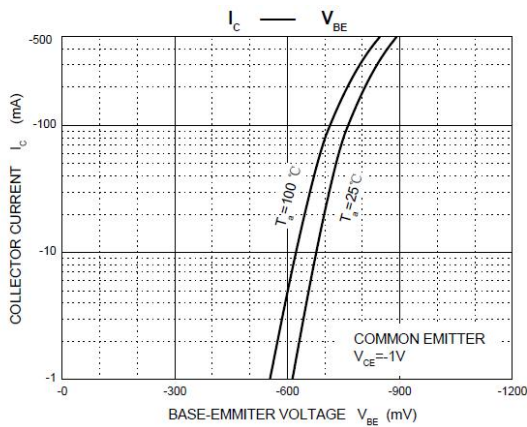
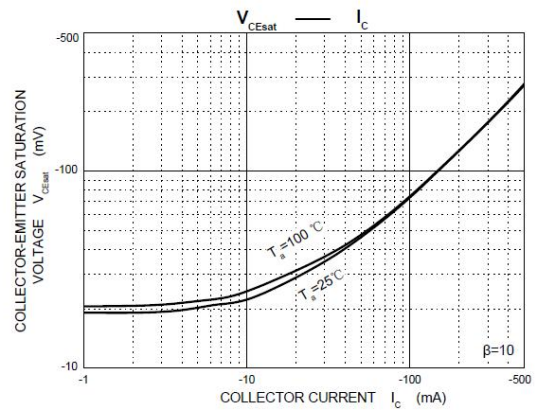
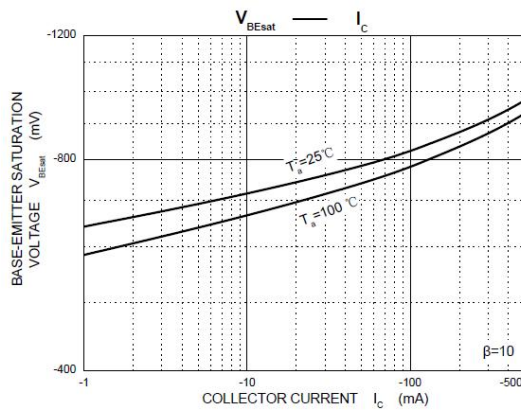
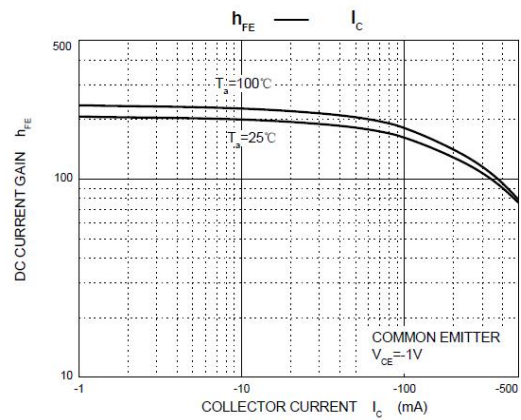
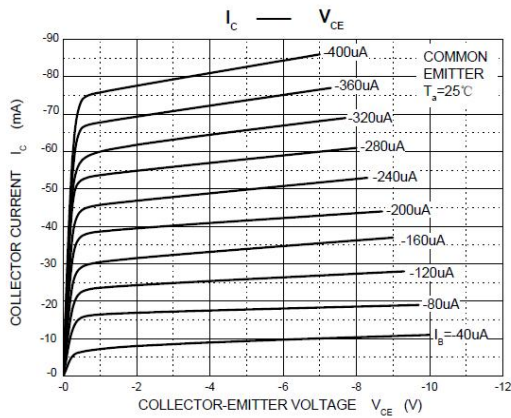

Note: Specifications are subject to change without notice. For more detail and update, please visit our website.